

GAMI

FABRICANT FRANÇAIS

J31-ATLANTA CHENE CLAIR

TABLE CARREE

REF. 085

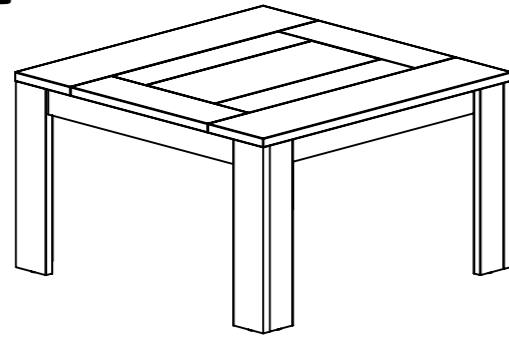
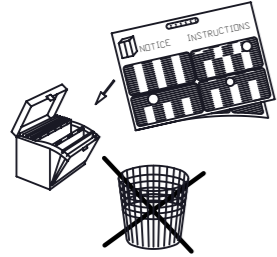

- FR - **IMPORTANT** - A lire soigneusement - A conserver pour consultation ultérieure
- GB - **IMPORTANT** - Read carefully and keep for information later
- ES - **IMPORTANTE** - Leer atentamente y guardar para consultas posteriores
- NL - **BELANGRIJK**, Lees deze instructies aandachtig en bewaar ze zodat u ze later nog kunt raadplegen
- DE - **WICHTIGER HINWEIS**. Bitte lesen sie diese unterlagen aufmerksam durch und bewahren sie sie auf
- IT - **IMPORTANTE** - Da leggere attentamente e da conservare per una ulteriore consultazione.
- RU - Это важно! Внимательно прочитайте данную инструкцию и сохраните ее для того, чтобы в дальнейшем при необходимости к ней обращаться.
- TR - **ÖNEMLI**, Dikkatli şekilde okuyunuz ve daha sonra başvurmak üzere saklayınız.



1 H

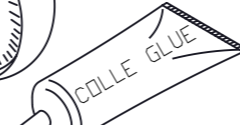

1 x
Réf. 11090



12 x
Réf. 363



50 mm



38 mm

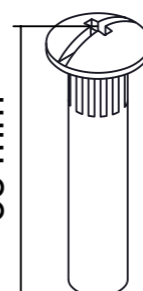

4 x
Réf. 10814

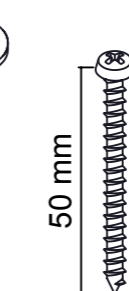

50 mm

4 x
Réf. 24784

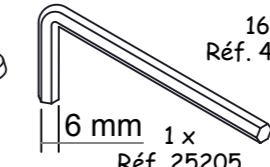

6 mm 1 x
Réf. 25205



13 mm 4 x
Réf. 2565



8 x
Réf. 53286

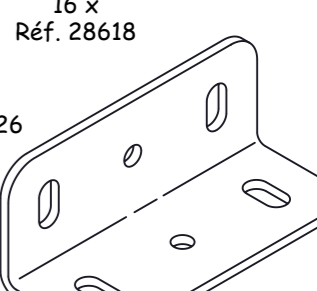

8 x
Réf. 42568



4 x
Réf. 7097

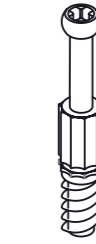

16 x
Réf. 44702



16 x
Réf. 28618



56 x
Réf. 5398

