

GAUTIER

REF.B60 - IMAGINE

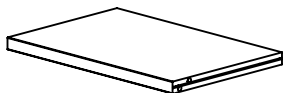

REF. 825 - ETAGERE L.50 P.37

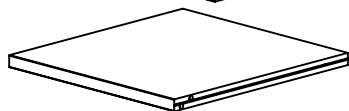

REF. 925 - ETAGERE L.50 P.60

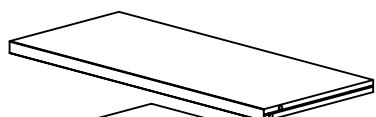

REF. 827 - ETAGERE L.75 P.37

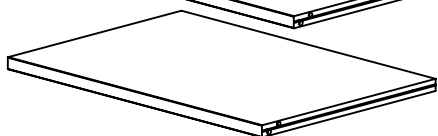

REF. 927 - ETAGERE L.75 P.60

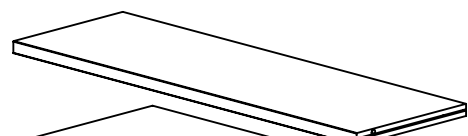

REF. 830 - ETAGERE L.100 P.37



REF. 930 - ETAGERE L.100 P.60

- FR** Nous vous remercions d'avoir choisi ce meuble. Pour garantir une satisfaction totale, il est très important que vous suiviez phase par phase les instructions de montage.
- GB** Thank you for buying this furniture. For your total satisfaction, it is very important that you follow the assembly instructions step by step.
- ES** Le agradecemos que haya elegido este mueble. Para garantizar una total satisfacción, es muy importante que siga todos los pasos de las instrucciones de montaje.
- NL** Wij danken u dat u voor dit meubel gekozen heeft. Voor een optimaal gebruik van het meubel is het van het grootste belang dat u stap voor stap de montage-instructies volgt.
- DE** Wir danken Ihnen, dass Sie sich für dieses Möbelstück entschieden haben. Bitte befolgen Sie die Montageanleitung genau, damit Sie mit dem fertigen Möbel vollkommen zufrieden sind.
- IT** Vi ringraziamo per aver scelto questo mobile. Per garantire una totale soddisfazione, è molto importante che seguiate fase per fase le istruzioni di montaggio.
- RU** Спасибо за ваш выбор. Для правильной сборки необходимо внимательно прочитать инструкцию.
- TR** Bu eşyayı seçtiğiniz için teşekkür ediyoruz. Eksiksiz bir memnuniyet sağlamak için, montaj talimatlarını aşama aşama takip etmeniz çok önemlidir.

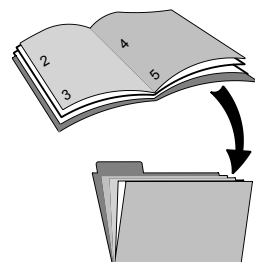
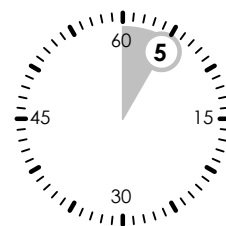
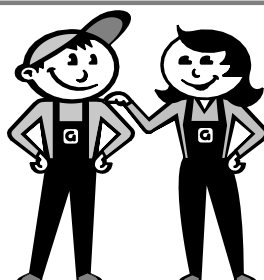
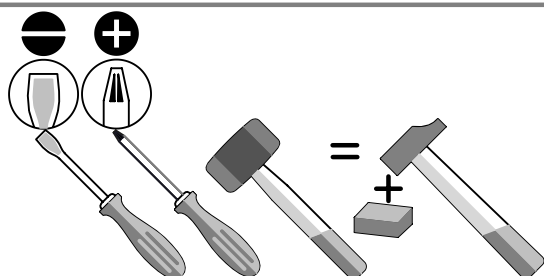

N° OM :

GAUTIER FRANCE BP 10 85510 LE BOUPERE FRANCE



contact@gautier.fr

08-04-19 001

- 1/4 -

GUI_B60-825

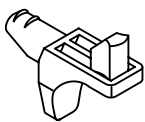

4 x
Réf. 65135

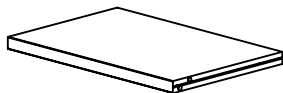

REF. 825
REF. 925

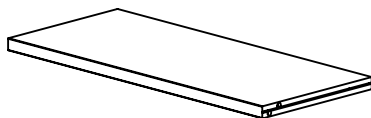

REF. 827
REF. 927

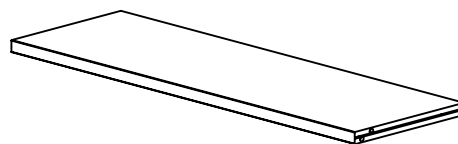

REF. 830
REF. 930

REF. 825
REF. 827
REF. 830



4 x
Réf. 65135

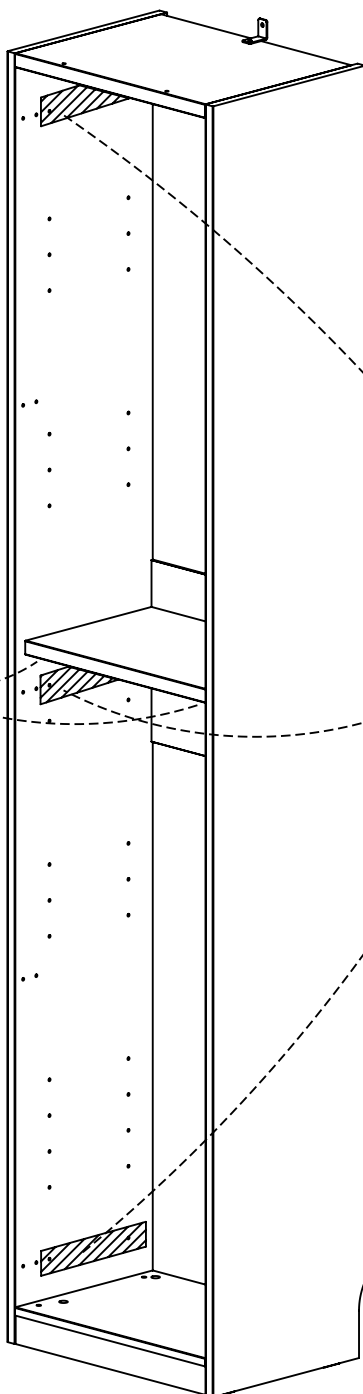
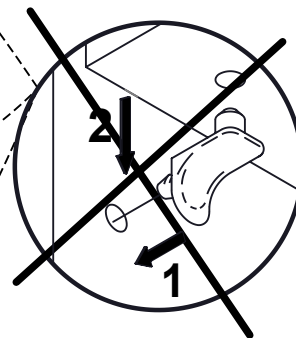
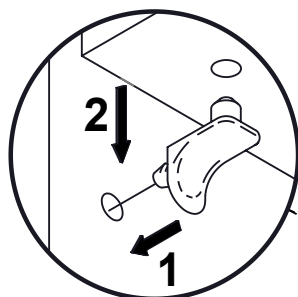

1

REF. 925
REF. 927
REF. 930



4 x
Réf. 65135

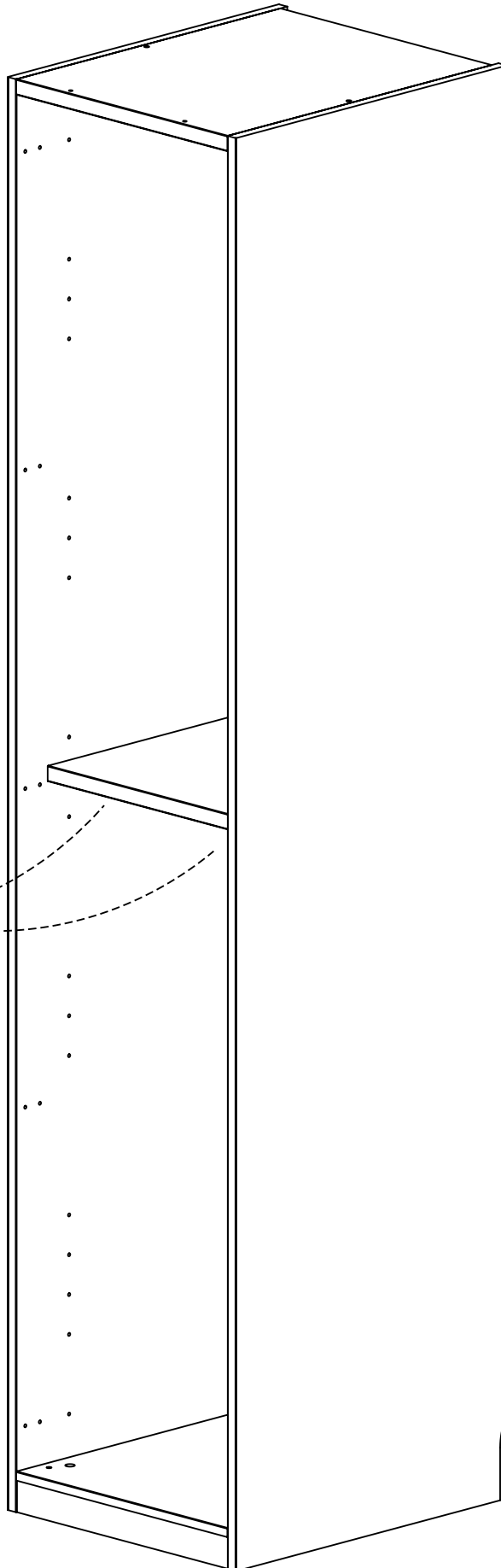

1

**INSTRUCTIONS DE RECYCLAGE - RECYCLING INSTRUCTIONS - INSTRUCCIONES DE RECICLAJE
 RECYCLING INSTRUCTIES - RECYCLING-ANWEISUNGEN - ISTRUZIONI DI RICICLAGGIO
 ИНСТРУКЦИЯ ПО УТИЛИЗАЦИИ - GERİ DÖNÜŞÜM TALİMATLARI**

- FR** Lors de l'élimination de votre mobilier usagé, les composants en bois, en plastique et en métal peuvent être séparés et être dirigés en déchetterie vers les contenants appropriés pour favoriser leur valorisation. Toutefois, si votre déchetterie est équipée d'une benne "meuble", vous pouvez déposer votre mobilier en l'état; l'éco-organisme gestionnaire de la filière DEA (www.eco-mobilier.fr) prendra en charge les opérations nécessaires à la valorisation optimale de celui-ci. Enfin n'oubliez pas que vous pouvez prolonger la durée de vie de vos produits usagés en contactant les associations caritatives de votre région.
- GB** When your furniture is no longer of use, its wood, plastic and metal components can be separated out and placed in the appropriate bins to be recycled. But remember that you may be able to extend the useful life of used furniture by passing it on to a charitable association in your neighbourhood.
- ES** Cuando elimine su mobiliario usado, los componentes de madera, plástico y metal pueden separarse y llevarse al vertedero y tirarse en los contenedores apropiados para su reciclaje. No obstante, no olvide que podrá prolongar la duración de vida de sus productos usados si se pone en contacto con las asociaciones de voluntariado social de su región.
- NL** Houten, plastic en metalen onderdelen van uw afgedankte meubels kunt u in gescheiden vorm aanbieden bij een afvalverzamelpunt en in de daarvoor bestemde containers werpen zodat ze opnieuw gebruikt kunnen worden. U kunt natuurlijk ook nog een tweede leven geven aan uw meubels door contact op te nemen met een liefdadigheidsinstelling bij u in de buurt.
- DE** Die Holz-, Kunststoff und Metallteile Ihrer Altmöbel können getrennt und in einem Wertstoffhof dem entsprechenden Recycling zugeführt werden. Ihre Altmöbel können jedoch auch für andere noch nützlich sein - wenden Sie sich an karitative Vereine in Ihrer Umgebung-Wohnregion.
- IT** Al momento dell'eliminazione del vostro mobile usato, i componenti in legno, in plastica ed in metallo possono essere separati ed essere portati in discarica verso i contenitori idonei per favorire la loro valorizzazione. Tuttavia, non dimenticate che potreste prolungare la durata di vita dei vostri prodotti usati contattando le associazioni caritative della vostra regione.
- RU** Для того, чтобы избавиться от старой мебели, можно рассортировать детали из дерева, пластика и металла и отправить в пункты сбора утиля для их переработки и вторичного использования. Однако, не забывайте, что вы можете продлить срок службы изделий, связавшись с благотворительными организациями вашего региона.
- TR** Eski mobilyanızı elden çıkarırken, ahşap, plastik ve metal bileşenler ayrıştırılabilir ve özel bir atık boşaltma yerinde tekrar değerlendirilmelerine katkıda bulunmak için uygun konteynirlara bırakılabilir. Ancak unutmayınız ki bölgenizdeki hayır kurumlarıyla itibata geçerek eskimiş ürünlerinizin ömrünü uzatabilirsiniz.

