

Numéro de pièce	Designation	Qte	Epais	Dim1	Dim2
925003010	COTE GAUCHE US	1	16	1488	397
925003020	COTE DROIT US	1	16	1488	397
925001030	SEPARATION US	16	16	360	370
925003040	SEPARATION MILIEU US	1	16	1488	397
925003050	DESSOUS US	1	16	1914	398
925003060	DESSUS US	1	16	1914	398
925002070	TABLETTE US	6	16	932	396
925001080	DERRIERE AG	8	3	942	370
925001090	PORTE US	24	12	356	293
925002100	TASSEAU US	2	33	800	33
925002110	PIED DECOUPE US	3			

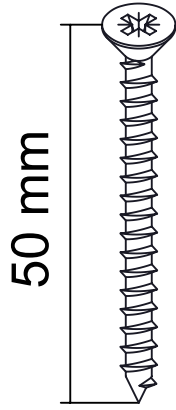

36 x  
Réf. 62362



4 x  
Réf. 6786



36 x  
Réf. 62370

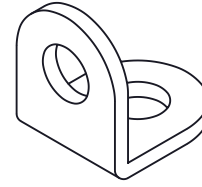

24 x  
Réf. 35779



24 x  
Réf. 51616



24 x  
Réf. 16293

### Fixation Murale

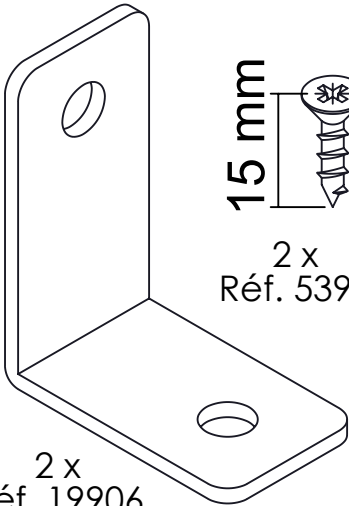

2 x  
Réf. 19906

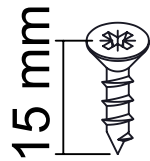

2 x  
Réf. 5397

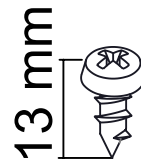

12 x  
Réf. 9766

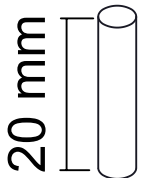

48 x  
Réf. 3484



48 x  
Réf. 53542

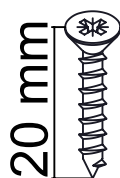

20 x  
Réf. 35782

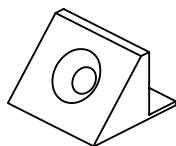

20 x  
Réf. 64626

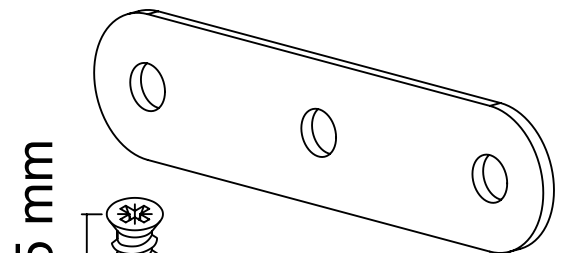

24 x Pattes

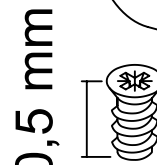

72 x  
Réf. 13758

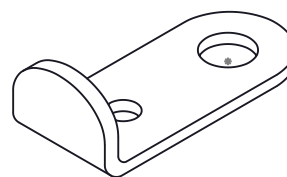

24 x  
Réf. 9332

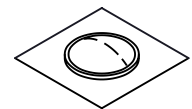

24 x  
Réf. 31701

