

Numéro de pièce	Designation	Qte	Epais	Dim1	Dim2
925001030	SEPARATION US	6	16	360	370
925002010	COTE GAUCHE US	1	16	1112	397
925002020	COTE DROIT US	1	16	1112	397
925001050	DESSUS US	1	16	966	398
925001060	DESSUS US	1	16	966	398
925002070	TABLETTE US	2	16	932	396
925001080	DÉRIÈRE AG	3	3	942	370
925001090	PORTE US	9	12	356	293
925002100	TASSEAU US	1	33	800	33
925002110	PIED DECOUPE US	2			

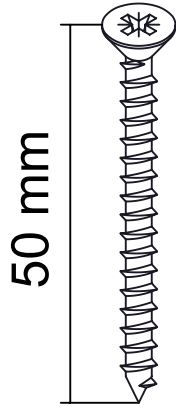

16 x
Réf. 62362



2 x
Réf. 6786



16 x
Réf. 62370

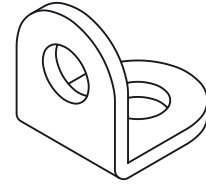

9 x
Réf. 35779

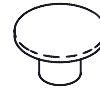

9 x
Réf. 51616



9 x
Réf. 16293

Fixation Murale

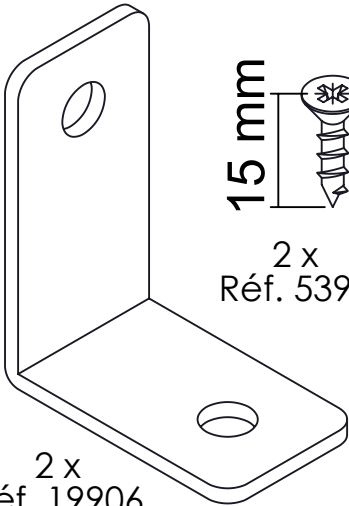

2 x
Réf. 19906

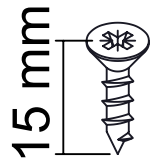

2 x
Réf. 5397

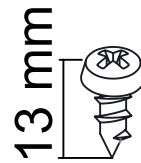

8 x
Réf. 9766

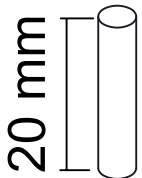

18 x
Réf. 3484



18 x
Réf. 53542

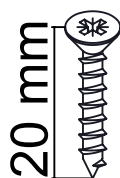

8 x
Réf. 35782

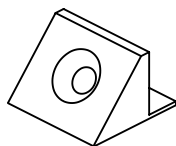

8 x
Réf. 64626

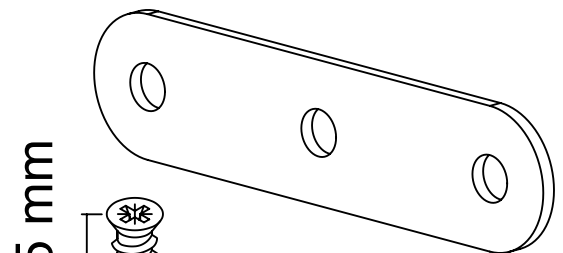

10,5 mm
27 x
Réf. 13758

9 x Pattes

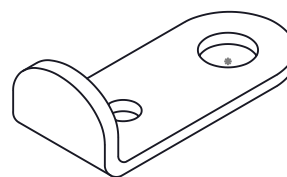

9 x
Réf. 9332

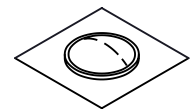

9 x
Réf. 31701

